

## SECTION P

### LUBRICATION

- Section No. P.1 Daily service.  
*Engine.*
- Section No. P.2 3,000 miles (5000 km.) service.  
*Engine oil change.*  
*Air cleaners.*  
*Carburettor dampers.*  
*Steering gear.*  
*Propeller shaft.*  
*Gearbox.*  
*Rear axle.*  
*Hand brake cable.*
- Section No. P.3 6,000 miles (10000 km.) service.  
*Distributor.*  
*Gearbox oil change.*  
*Rear axle oil change.*  
*Engine oil filter.*  
*Dynamo.*
- Section No. P.4 12,000 miles (20000 km.) service.  
*Flushing the engine.*  
*Water pump.*  
*Steering gearbox.*

Correct lubrication of any piece of mechanism is of paramount importance, and in no instance is it of greater importance than in the correct choice of lubricant for a motor-car engine. Automobile engines have different characteristics, such as operating temperatures, oiling systems, size of oilways, clearances, and similar technicalities, and the use of the correct oil is therefore essential.

NOTE.—The letters given in brackets throughout the Manual refer to the appropriate section of the recommended lubricants table given on page P.2.

# P

## LUBRICATION

The following is a list of lubricants recommended :

<b>A ENGINE AND AIR CLEANERS</b>								
<i>Climatic conditions</i>	Mobil	Shell	BP	Filtrate	Sternol	Duckham's	Castrol	Esso
Tropical and temperate down to 0° C. (32° F.)	Mobiloil A	Shell X-100 30	Energol S.A.E. 30	Filtrate Medium 30	Sternol W.W. 30	Duckham's NOL Thirty	Castrol X.L.	Esso Extra Motor Oil 20W/30
Extreme cold down to -12° C. (10° F.)	Mobiloil Arctic	Shell X-100 20W	Energol S.A.E. 20W	Filtrate Zero 20/20W	Sternol W.W. 20	Duckham's NOL Twenty	Castrolite	Esso Extra Motor Oil 20W/30
Arctic consistently below -12° C. (10° F.)	Mobiloil 10W	Shell Rotella 10W	Energol S.A.E. 10W	Filtrate Sub-Zero 10W	Sternol W.W. 10	Duckham's NOL Ten	Castrol Z	Esso Motor Oil 10
<b>GEARBOX</b>								
All conditions	Mobiloil A	Shell X-100 30	Energol S.A.E. 30	Filtrate Medium 30	Sternol W.W. 30	Duckham's NOL Thirty	Castrol X.L.	Esso Extra Motor Oil 20W/30
<b>B REAR AXLE (HYPOID) AND STEERING GEAR</b>								
All conditions down to -12° C. (10° F.)	Mobilube G.X. 90	Shell Spirax 90 E.P.	Energol S.A.E. 90 E.P.	Filtrate Hypoid Gear 90	Ambroleum E.P. 90	Duckham's Hypoid 90	Castrol Hypoy	Esso Gear Oil G.P. 90
Arctic consistently below -12° C. (10° F.)	Mobilube G.X. 80	Shell Spirax 80 E.P.	Energol S.A.E. 80 E.P.	Filtrate Hypoid Gear 80	Ambroleum E.P. 80	Duckham's Hypoid 80	Castrol Hypoy Light	Esso Gear Oil G.P. 80
<b>C WATER PUMP AND LUBRICATION NIPPLES</b>								
All conditions	Mobilgrease M.P.	Shell Retinax A	Energrease L. 2	Filtrate Super Lithium Grease	Ambroline L.H.T.	Duckham's L.B. 10 Grease	Castrolase L.M.	Esso Multi-purpose Grease H
<b>D UTILITY LUBRICANT, S.U. CARBURETTER DAMPERS, OILCAN POINTS, ETC.</b>								
All conditions	Mobiloil Arctic	Shell X-100 20W	Energol S.A.E. 20W	Filtrate Zero 20/20W	Sternol W.W. 20	Duckham's NOL Twenty	Castrolite	Esso Extra Motor Oil 20W/30
<b>E UPPER CYLINDER LUBRICANT</b>								
All conditions	Mobil Upperlube	Shell Upper Cylinder Lubricant	Energol U.C.L.	Filtrate Petroyle	Sternol Magikoyl	Duckham's Adcoild Liquid	Castrollo	Esso Upper Cylinder Lubricant

## Section P.1

### DAILY SERVICE

#### ENGINE (A)

Inspect the oil level in the engine and refill if necessary to the 'MAX' mark on the dipstick. The oil filler cap is on top of the rocker cover and is released by turning it anti-clockwise.

## Section P.2

### 3,000 MILES (5000 Km.) SERVICE

#### ENGINE OIL CHANGE (A)

Drain the oil from the engine sump after 3,000 miles (5000 km.). The drain plug is on the right-hand side of the sump and should be removed after a journey, while the oil is still warm and will drain easily.

The sump capacity is 7½ pints (9 U.S. pints, 4.26 litres). Refill the engine with new oil.

#### AIR CLEANERS (A)

Wash the filter element in petrol and allow to dry. Re-oil the elements and allow to drain before reassembling.

It is only necessary to withdraw the two hexagon-headed screws and lift off the outer cover to release each corrugated element. Reassemble the front element with the corrugations clear of the breather spigot in the main filter case.

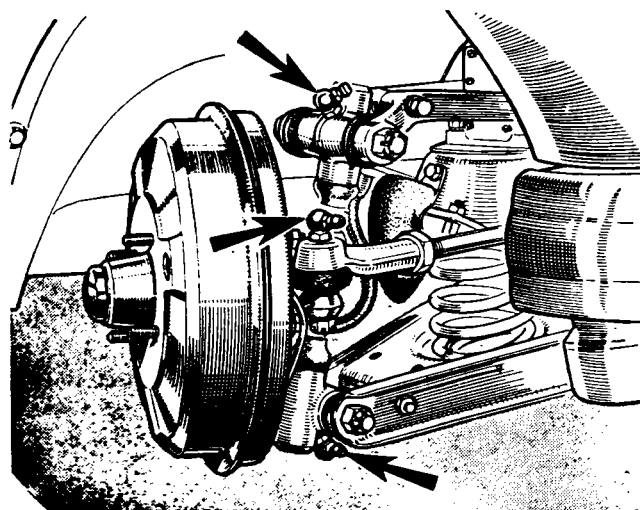

Fig. P.1

*Nipples on the front suspension*

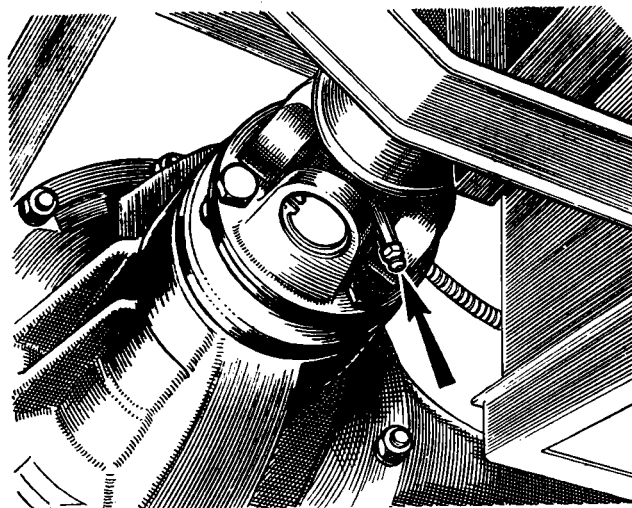

Fig. P.2

*The nipple on the rear universal joint*

#### CARBURETTOR DAMPERS (D)

Unscrew the oil cap at the top of each suction chamber, pour in a small quantity of thin engine oil and replace the caps. Under no circumstances should a heavy-bodied lubricant be used. Failure to lubricate the piston dampers will cause the pistons to flutter and reduce acceleration.

#### STEERING GEAR (C)

Grease nipples are provided at the top and bottom of each swivel pin and on the steering tie-rods. The gun should be applied to the nipples and three or four strokes given.

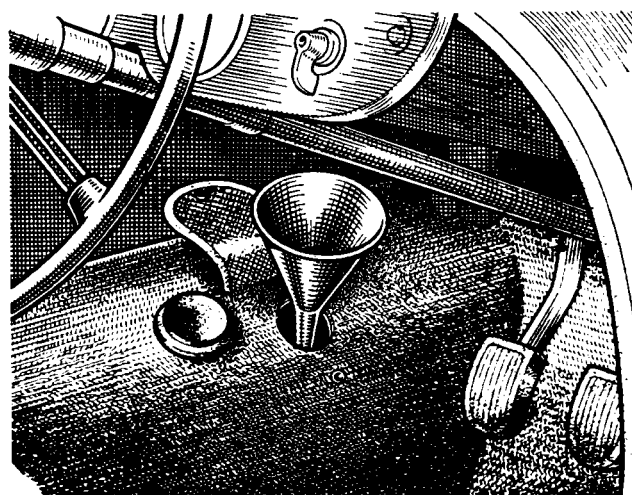

Fig. P.3

*Topping up the gearbox*

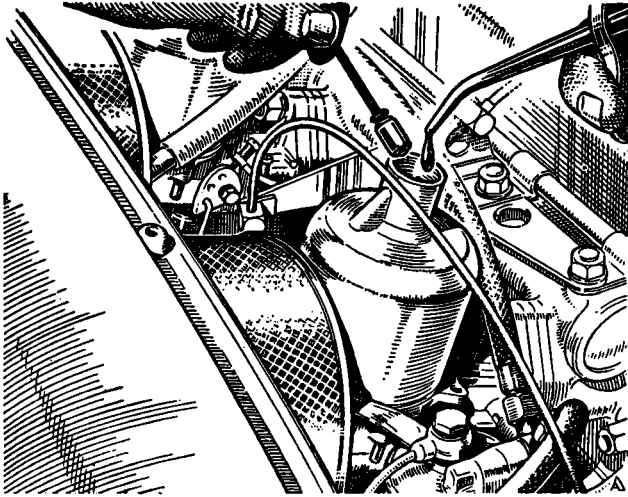

Fig. P.4

The carburettor suction chamber damper oil must be replenished every 3,000 miles (5000 km.)

### PROPELLER SHAFT (C)

The joint at each end of the propeller shaft is provided with a nipple. Later cars have a third propeller shaft nipple on the sliding spline joint.

### GEARBOX (A)

Top up the oil level and ensure that the gearbox is not filled above the 'HIGH' mark on the dipstick. If the level is too high oil may get into the clutch case and cause clutch slip. The combined filler plug and dipstick is located beneath the rubber plug in the gearbox cover.

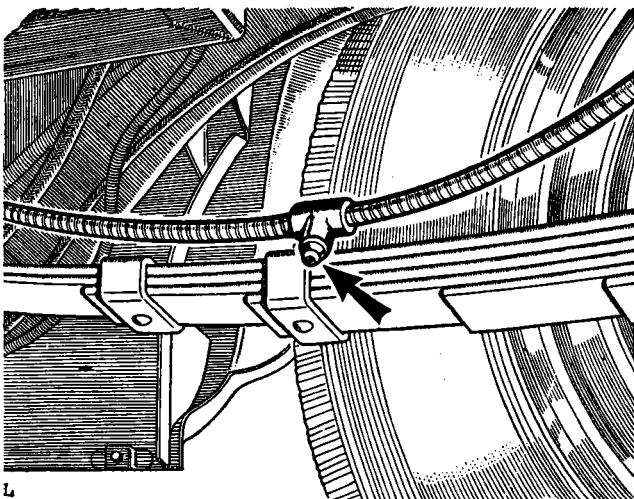

Fig. P.5

A hand brake cable greaser

### REAR AXLE (B)

The combined filler and level plug is reached from below the rear of the car. The oil level should be replenished if necessary to the level of the filler plug hole. (See Fig. P.9)

**NOTE.**—It is essential that only Hypoid oil be used in the rear axle.

### HAND BRAKE CABLE (C)

The grease nipple on the hand brake cable should be given three or four strokes with a grease gun.

## Section P.3

### 6,000 MILES (10000 Km.) SERVICE

Carry out the instructions detailed in Section P.2 except those under 'GEARBOX' and 'REAR AXLE' (Section P.2), and continue with the following.

### DISTRIBUTOR

#### Cam bearing (D)

Lift the rotor off the top of the spindle by pulling it squarely and add a few drops of oil to the cam bearing. Do not remove the screw which is exposed.

There is a clearance between the screw and the inner face of the spindle for the oil to pass.

Replace the rotor with its drive lug correctly engaging the spindle slot and push it onto the shaft as far as it will go.

#### Cam (C)

Lightly smear the cam with a very small amount of grease, or if this is not available, clean engine oil can be used.

#### Automatic timing control (D)

Carefully add a few drops of oil through the hole in the contact breaker base through which the cam passes. Do not allow the oil to get on or near the contacts. Do not over-oil.

#### Contact breaker pivot (D)

Add a spot of oil to the moving contact pivot pin.

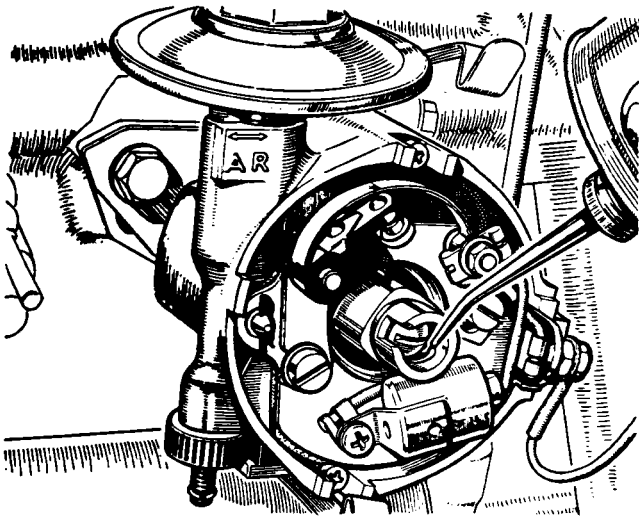

Fig. P.6  
*Distributor bearing lubrication*

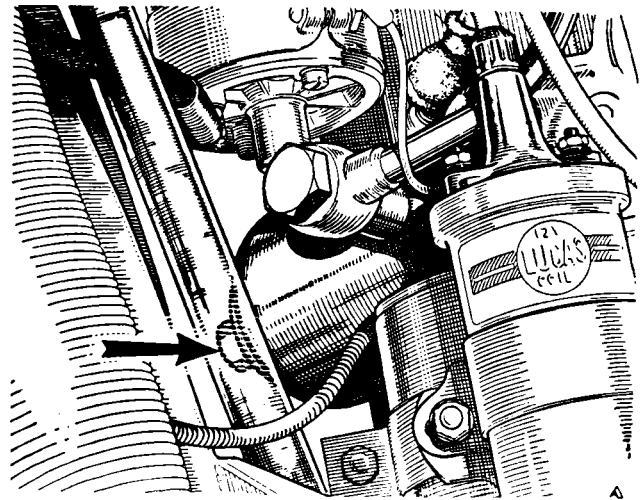

Fig. P.8  
*The external oil filter*

**GEARBOX OIL CHANGE (A)**

Drain the gearbox oil.

When the gearbox has been drained completely, 4½ Imperial pints (5.6 U.S. pints, 2.56 litres) of oil are required to fill it. The oil should be poured in through the filler plug shown in Fig. P.3.

**REAR AXLE OIL CHANGE (B)**

Remove the drain plug and drain out the oil. Refill with Hypoid oil to the level of the filler plug hole.

Approximately 2½ pints (2.7 U.S. pints, 1.28 litres) of oil are required to refill the axle.

**ENGINE OIL FILTER (A)**

Fit a new engine oil filter element. The filter is released by unscrewing the central bolt securing the filter body to the filter head. When fitting the new element, make sure that the seating washer for the filter body is in good condition and that the body is fitted securely to prevent oil leaks.

Ensure that the washers below the element inside the bowl are fitted correctly. The small felt washer must be positioned between the element pressure plate and the metal washer above the pressure spring. It is essential for correct oil filtration that the felt washer should be in good condition and be a snug fit on the centre-securing bolt.

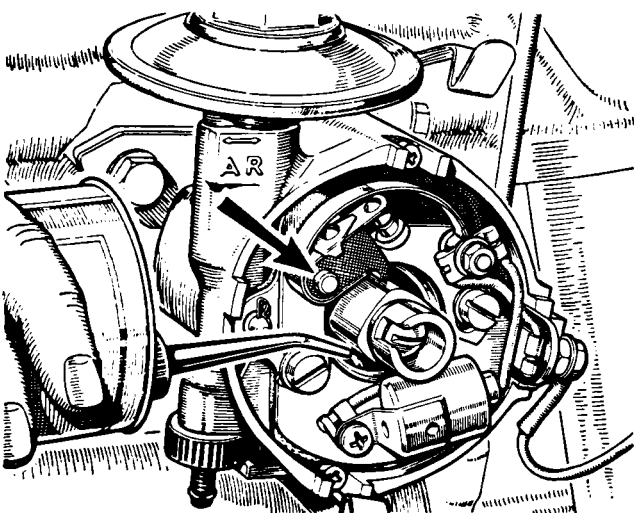

Fig. P.7  
*Lubricating the distributor advance mechanism*

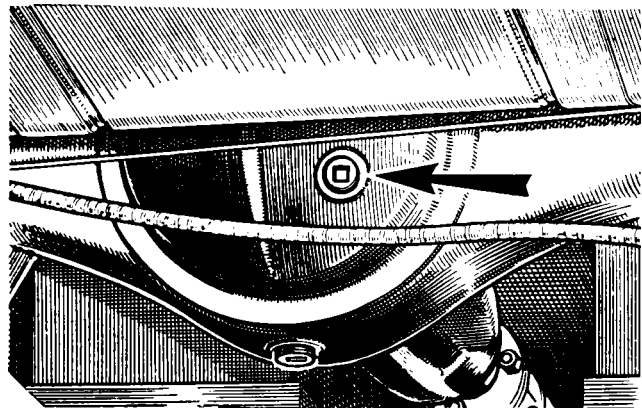

Fig. P.9  
*The rear axle level plug*

# P

## LUBRICATION

### DYNAMO (D)

Add two drops of engine oil to Ref. D, page P.2, in the lubrication hole in the centre of the rear end bearing plate.

Do not over-oil.

### Section P.4

#### 12,000 MILES (20000 Km.) SERVICE

Carry out the instructions detailed in Sections P.2 and P.3 in addition to the following.

#### FLUSHING THE ENGINE

Flush the engine with a flushing oil supplied by one of the recommended manufacturers (page P.2). This operation must be carried out prior to oil filter changing. Use approximately half the normal sump capacity and run the engine for 2½ to 3 minutes at a fast tick-over, after which special care must be taken to ensure complete drainage of the flushing oil.

It is recommended that at 24,000 miles (40000 km.) the sump and oil pump pick-up strainer should be removed for cleaning.

#### WATER PUMP (C)

Remove the water pump plug on the water pump casing and add a small quantity of grease. The lubri-

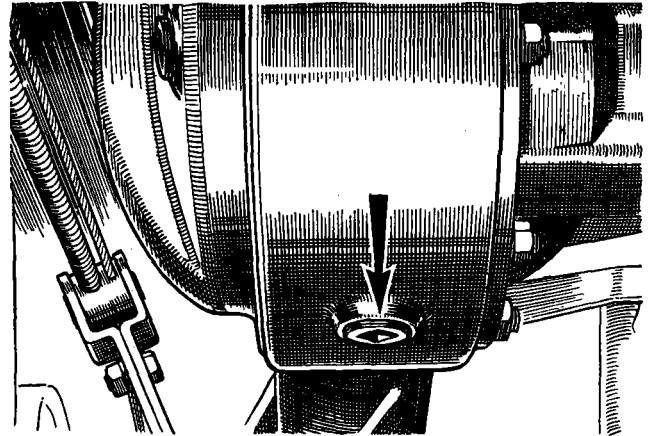

Fig. P.10

*The rear axle drain plug*

cation of the pump must be done very sparingly, otherwise grease will pass the bearings and reach the face of the carbon sealing ring, impairing its efficiency.

#### STEERING GEARBOX (B)

The two nipples for the steering gearbox and pinion are reached from under the bonnet.

Give the gearbox nipple 15 strokes **only**, and the pinion nipple five strokes **only** at the same time, with a gun filled with oil.

---

# LUBRICATION CHART

## KEY TO LUBRICATION CHART

### DAILY

- (1) ENGINE. Check the oil level with the dipstick, and replenish if necessary with oil to Ref. A.

### EVERY 3,000 MILES (5000 Km.)

- (2) GEARBOX. Check the oil level with the dipstick, and replenish if necessary with oil to Ref. A.
- (3) REAR AXLE. Remove the filler plug and replenish to the filler plug level with oil to Ref. B.
- (4) STEERING. Give three or four strokes of the gun filled to Ref. C to the nipples on the steering joints.
- (5) PROPELLER SHAFT. Give the shaft coupling and sliding joint nipples three or four strokes with the gun filled to Ref. C. Earlier cars have two propeller shaft nipples only.
- (6) HAND BRAKE. Give the cable nipples three or four strokes of the gun filled with grease to Ref. C.
- (7) CARBURETTORS. Remove the cap from the top of each suction chamber and add a few drops of oil to Ref. D.
- (8) AIR CLEANERS. Wash the filter elements and allow to dry. Re-oil the elements with oil to Ref. A and allow to drain before reassembly.
- (9) ENGINE. Drain off the old oil from the sump and refill with fresh oil to Ref. A.

### EVERY 6,000 MILES (10000 Km.)

- (10) DISTRIBUTOR. Withdraw the rotor arm and add a few drops of oil to Ref. D to the cam bearing and

to the advance mechanism through the gap round the cam spindle. Smear the cam lightly with grease to Ref. C and add a spot of oil to the contact breaker pivot.

- (11) OIL FILTER. Release the filter bowl, wash in fuel, and fit a new element.
- (12) GEARBOX. Drain off the old oil and refill with fresh oil to Ref. A.
- (13) REAR AXLE. Drain off the old oil and refill with fresh oil to Ref. B.
- (14) DYNAMO. Add a few drops of oil to Ref. D through the oil hole in the commutator end bearing.

### EVERY 12,000 MILES (20000 Km.)

- (15) STEERING. Give up to 10 strokes to the nipple on the steering gearbox and two strokes only to the pinion shaft nipple. Use oil to Ref. B.
- (16) WATER PUMP. Remove the plug from the water pump and lubricate sparingly with grease to Ref. C.

### MULTIGRADE MOTOR OILS

In addition to the recommended lubricants listed in the Manual we approve the use of these motor oils, as produced by the oil companies shown in our publications, for all climatic conditions unless the engine is in poor mechanical condition.

**NOTE.—Oil and grease references are to be found on page P.2.**



# THE 'MGA' AND 'MGA 1600' LUBRICATION CHART

